

AN6164K, AN6164S

Constant Voltage Drive Speech Network Circuits

Overview

The AN6164K and AN6164S are ICs for constant voltage drive type speech networks.

They incorporate a speaker amplifier and attenuator and suitable for the car telephone and business telephone.

Features

- Capable of interfacing with the piezo-electric receivers and dynamic receivers
- Capable of interfacing with the piezo-electric transmitters and ECM type transmitters
- Balance input for both receiver and transmitter system in order to prevent mixture of humming noises
- Capable of muting each amplifier by external control
- Built-in attenuator circuit in the receiver system to allow 7-step adjustment of attenuation (0 to -30dB) with the switch 3 terminals
- Built-in standby circuit for the power supply to allow low power consumption ; supply current of 15 μ A or less in the standby mode

AN6164K

Unit : mm

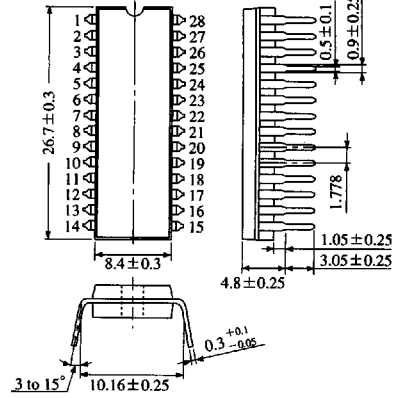

28-pin Shrink DIL Plastic Package (SDIP028-P-0400A)

AN6164S

Unit : mm

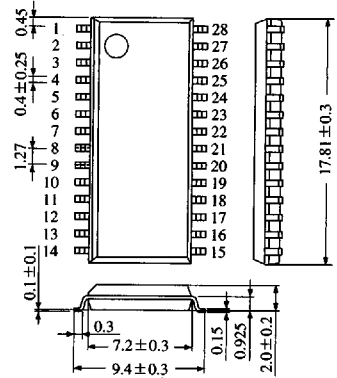

28-pin PANAFLAT Plastic Package (SOP028-P-0375A)

Block Diagram

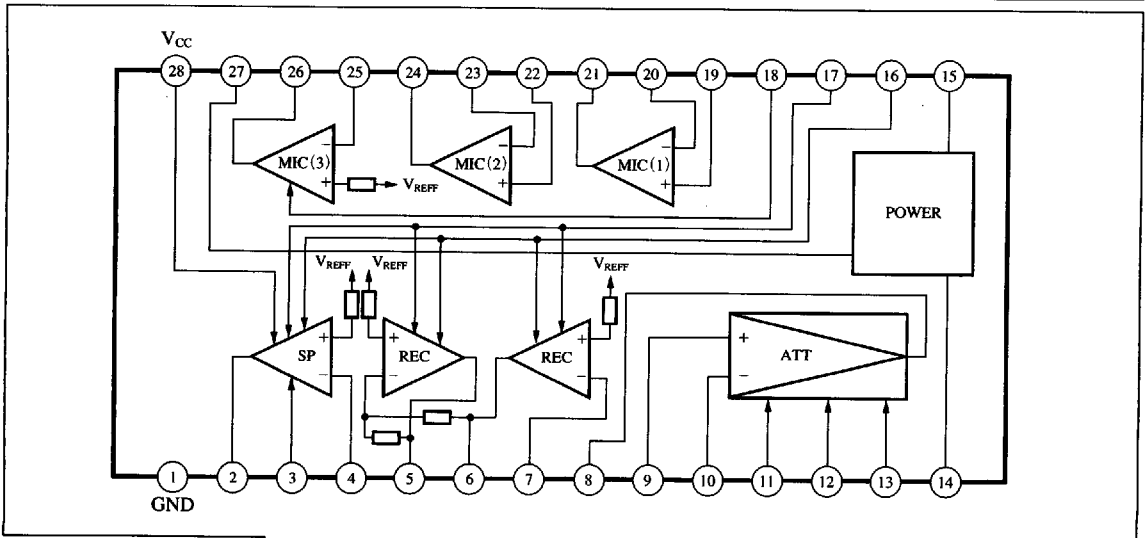

6932852 0013063 7&T

■ Absolute Maximum Ratings (Ta=25°C)

Parameter	Symbol	Rating	Unit
Supply voltage	V _{CC}	-0.3 to +14.4	V
Supply current	I _{CC}	1	A
Power dissipation	P _D	380*	mW
Operating ambient temperature	T _{opr}	-20 to +75	°C
Storage temperature	T _{stg}	-55 to +125	°C

* Operating ambient temperature Ta=75°C, mounted onto the glass epoxy PCB (50×50×1.2mm)

■ Recommended Operating Range (Ta=25°C)

Parameter	Symbol	Range
Operating supply voltage range	V _{CC}	4.5 to 8V

■ Electrical Characteristics (V_{CC}=5V, f=1kHz, Ta=25°C)







Parameter	Symbol	Condition	min	typ	max	Unit
Current consumption (SP MODE)	I _{CC} (SP)	Measure current consumption at V _{CC} =8V and at the speaker mode.	5	11	17	mA
Current consumption (STANDBY MODE)	I _{st}	Measure current consumption at V _{CC} =8V and at the standby mode.	—	—	15	μA
Microphone amplifier (1) open circuit gain	G _v (M1)	Input a signal to the Pin⑨ and measure the open circuit gain at the Pin②.	55	—	—	dB
Microphone amplifier (1) output level	V _O (M1)	Measure a distortion factor at the Pin② at gain=20 dB, load=600Ω, and output=-2dB.	—	—	5	%
Microphone amplifier (1) noise output voltage	V _{no} (M1)	Measure the noise level with DIN/AUDIO at R _g =2.2kΩ and gain=20 dB.	—	-90	-80	dBV
Receiver amplifier gain	G _v (REC)	Set the gain to 20 dB with an external resistor and measure the gain at V _{in} =-25 dBV.	18	20	22	dB
Receiver amplifier output level	V _O (REC)	Measure a distortion factor at gain=20 dB, load=100Ω, and output=0 dBV.	—	—	5	%
Receiver amplifier noise output voltage	V _{no} (REC)	Measure the noise level with DIN/AUDIO at R _g =2.2kΩ and gain=20 dB.	—	-80	-70	dB
ΔATT (1)	ΔATT (1)	Input a signal (-10 dBV) to the Pin⑨ and measure the output level. Ground the Pin①.	-7	-5	-3	dB
ΔATT (2)	ΔATT (2)	Input a signal (-10 dBV) to the Pin⑨ and measure the output level. Ground the Pin②.	-12	-10	-8	dB
ΔATT (3)	ΔATT (3)	Input a signal (-10 dBV) to the Pin⑨ and measure the output level. Ground the Pin③.	-17	-15	-13	dB
ATT	ATT	Input a signal (-10 dBV) to the Pin⑨ and measure the output level.	-2	0	+2	dB
Speaker amplifier open circuit gain	G _v (SP)	Input a signal to the Pin④ and measure the open circuit gain of the Pin②.	40	—	—	dB
Speaker amplifier output level	V _O (SP)	Measure a distortion factor at the Pin② at gain=26 dB, load=16Ω, and output=0 dBV.	—	—	5	%
Speaker amplifier noise output voltage	V _{no} (SP)	Measure the noise level with DIN/AUDIO at R _g =2.2kΩ and gain=26 dB.	—	-85	-75	dBV
Control voltage (H)	V (H)		2	—	V _{CC} +0.3	V
Control voltage (L)	V (L)		-0.3	—	+0.5	V
Control pin suction current	I _{cont}	Measure a current flowing out when the control pin is ground.	—	—	20	μA

ICs for Telephone

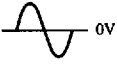
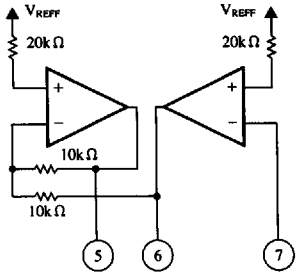
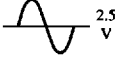
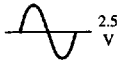
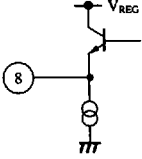
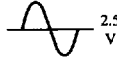
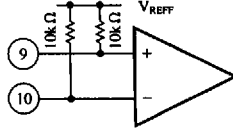
6932852 0013064 616

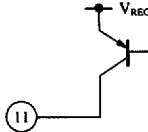
Panasonic

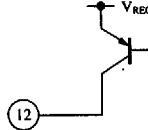

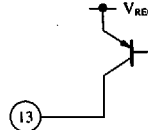
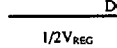
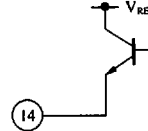
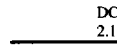
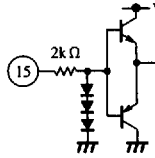



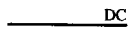
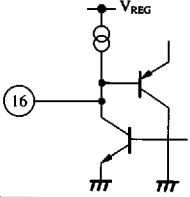
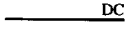
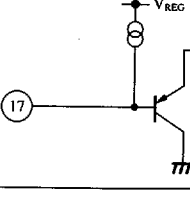

■ Pin Descriptions (cont.)

Pin No.	Pin name	Typical waveform	Description	Equivalent circuit
5	RO-2		Receiver output pins 2 and 1. Connects to the receiver through the coupling capacitor. The receiver connected is a 100Ω dynamic type or 1 kΩ piezo-electric type.	
6	RO-1			
7	REC input		Receiver input pin. Inputs a receiver signal through the coupling capacitor.	
8	ATT output		Attenuator output pin. Connects to the receiver amplifier and speaker amplifier through the coupling capacitor.	
9	ATT (+) input		Attenuator positive input pin and negative input pin. Inputs a receiver signal through the coupling capacitor.	
10	ATT (-) input			
11	ATT cont (1)		Attenuator control pin 1. The receiver gain is attenuated 5 dB by setting this pin to the L level.	
12	ATT cont (2)		Attenuator control pin 2. The receiver gain is attenuated 10 dB by setting this pin to the L level.	
13	ATT cont (3)		Attenuator control pin 3. The receiver gain is attenuated 15 dB by setting this pin to the L level.	
14	V _{REF}		Reference pin. Connects to GND through the electrolytic capacitor. The current obtainable from this pin is 7mA.	
15	STANDBY		Standby pin. Connects to the Pin [Ⓢ] through a resistor (2MΩ). The standby mode is set by setting this pin to the Low level.	

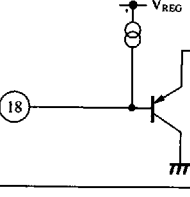
ICs for Telephone

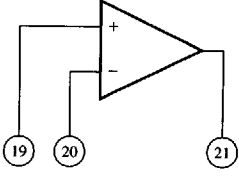

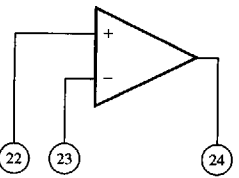

■ 6932852 0013066 499 ■

■ Pin Descriptions (cont.)

Pin No.	Pin name	Typical waveform	Description	Equivalent circuit
16	V _{CC} cont		Power rise control pin. Connects to GND through the electrolytic capacitor (4.7 μF) and resistor (100k Ω).	
17	REC/SP		Receiver/speaker selector pin. The speaker mode is selected by setting this pin to the H level, and receiver mode by setting to the L level.	
18	MIC mute		Microphone mute pin. Controls ON/OFF of the microphone (3) amplifier. Muted by setting this pin to the L level.	
19	MIC-1 input		Microphone (1) positive and negative input pins. Connects the ECM type microphone through the coupling capacitor.	
20	MIC-1 input			
21	MIC-1 output		Microphone (1) output pin. Capable of driving a 600 Ω load.	
22	MIC-2 input		Microphone (2) positive and negative input pins. Connects the ECM type microphone through the coupling capacitor.	
23	MIC-2 input			
24	MIC-2 output		Microphone (2) output pin. Capable of driving a 600 Ω load.	

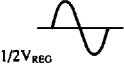
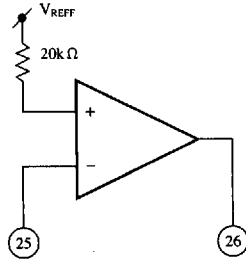
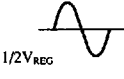
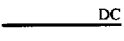
■ 6932852 0013067 325 ■

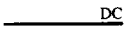
Pin Descriptions (cont.)

Pin No.	Pin name	Typical waveform	Description	Equivalent circuit
25	MIC-3 input		Microphone (3) input pin. Connects to the microphone (1) or microphone (2) through the coupling capacitor.	
26	MIC-3 output		Microphone (3) output pin. Capable of driving a 600Ω load.	
27	V _{REG}		Stabilized supply voltage pin. Connects to GND through the electrolytic capacitor.	
29	V _{CC}		Supply voltage pin. Connects to GND through the electrolytic capacitor.	

Supplementary Descriptions

Receiver Attenuator

☆About receiver attenuator

Since the AN6164K and AN6164S incorporate the attenuator circuit in the receiver system, you can adjust an amount of attenuator in 7 steps with the 3 pins, ⑪, ⑫, and ⑬.

The logic table is shown below.

Receiver Attenuation Amount

⑪	⑫	⑬	Attenuation amount (dB)
H	H	H	0
L	H	H	-5
H	L	H	-10
H	H	L	-15
L	H	L	-20
H	L	L	-25
L	L	L	-30
L	L	H	-15

■ Characteristics Curve

Microphone Amp. I/O Distortion Factor Characteristics

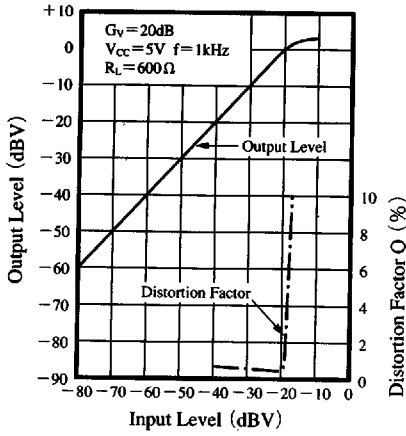

Receiver Amp. I/O Distortion Factor Characteristics

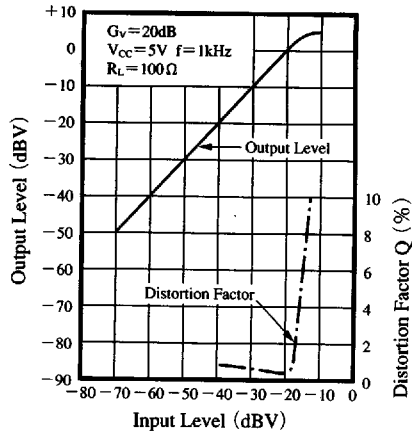

Speaker Amp. I/O Distortion Factor Characteristics

